



# BRAIME ELEVATOR COMPONENTS LTD.

England. LS10 1JZ  
Telephone: (0113)2457491  
Fax: (0113)2435021  
Web: www.braille.com  
e-mail: elevators@braille.co.uk



# SETEM

9, route de Corbie  
80800 LAMOTTE WARFUSEE  
Tél : (33) 03 22 42 32 26  
Fax : (33) 03 22 42 37 33  
Email : setem@aol.com  
www .braille.com/setem



# BRAIME ELEVATOR COMPONENTS LTD.

England. LS10 1JZ  
Telephone: (0113)2457491  
Fax: (0113)2435021  
Web: www.braille.com  
e-mail: elevators@braille.co.uk



# SETEM

9, route de Corbie  
80800 LAMOTTE WARFUSEE  
Tél : (33) 03 22 42 32 26  
Fax : (33) 03 22 42 37 33  
Email : setem@aol.com  
www .braille.com/setem

## ATEX Approved Inductive Proximity Sensor Type: P100V34A

### Dimensions - mm

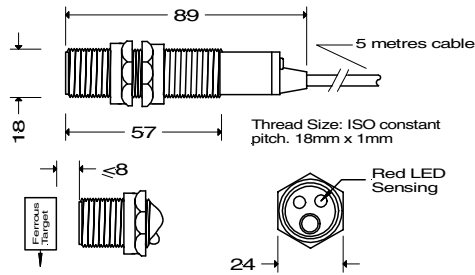

### Connections:- npn connection

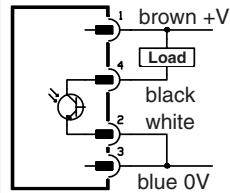

### pnp connection

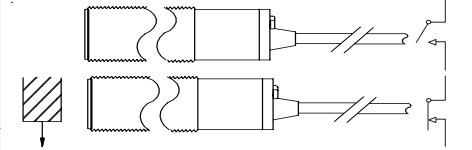
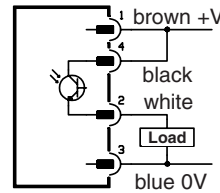

### Protection

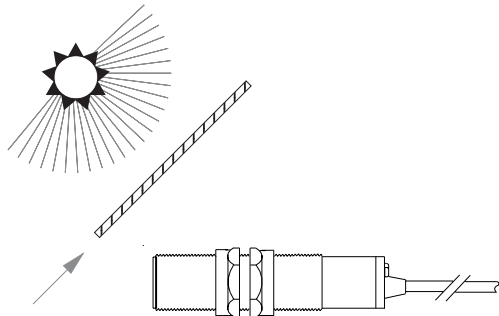

### npn connection

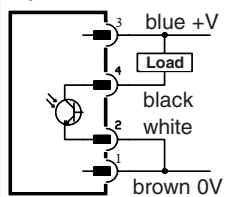

### pnp connection

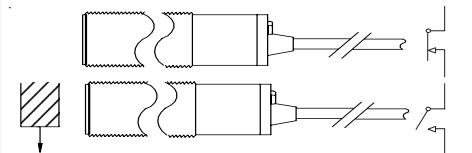
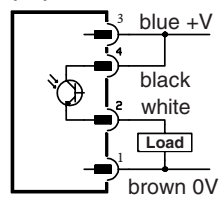

### Approval



Approval No:  
**Baseefa03ATEX0593X**

Category:  
**EXII 1D T100°C Tamb -15°C to +50°C IP65**

### Specification

Supply V ..... 10-30V dcc.  
Output ..... Opto-isolated transistor, npn or pnp use.  
Output Rating .. 100 mA 30V dc max.  
Max. Speed ..... 200 Hz.

->P10034ATEXMAN 644-051(A)

## ATEX Approved Inductive Proximity Sensor Type: P100V34A

### Dimensions - mm

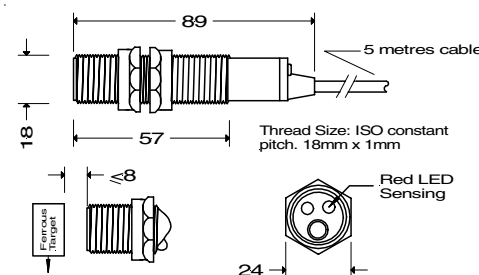

### Connections:- npn connection

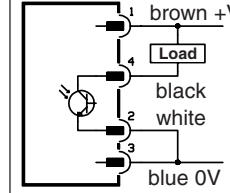

### pnp connection

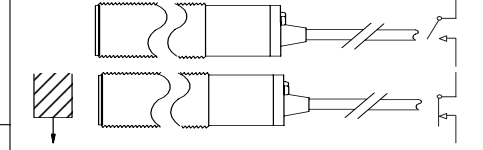
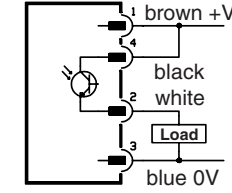

### Protection

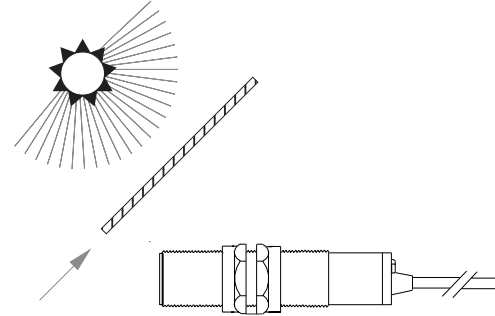

### npn connection

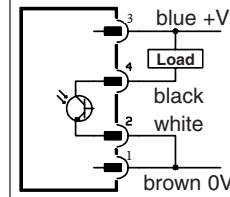

### pnp connection

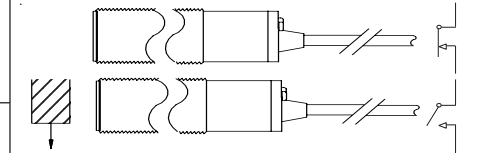
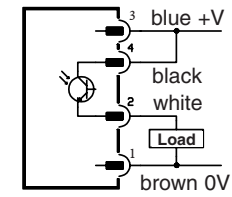

### Approval



Approval No:  
**Baseefa03ATEX0593X**

Category:  
**EXII 1D T100°C Tamb -15°C to +50°C IP65**

### Specification

Supply V ..... 10-30V dcc.  
Output ..... Opto-isolated transistor, npn or pnp use.  
Output Rating .. 100 mA 30V dc max.  
Max. Speed ..... 200 Hz.

->P10034ATEXMAN 644-051(A)